

UR12

USB AUDIO INTERFACE

Operation Manual

Benutzerhandbuch

Fonctions Détaillées

Manual de Operaciones

Manual de Operação

Manuale Operativo

使用说明书

オペレーションマニュアル



EN
DE
FR
ES
PT
IT
ZH
JA



Contents

Message from the Development Team	2
Panel Controls and Terminals	3
Front Panel	3
Rear Panel.....	4
Software.....	6
Using the UR12	9
Connection Examples	9
Configuring Audio Driver Settings on the DAW Software	10
Recording/Playback.....	10
Troubleshooting	13
Appendix	15
Block Diagrams.....	15

Message from the Development Team

Thank you for choosing the UR12 USB audio interface.

The UR12 is the most basic model in the popular and extensive UR series. The UR12 features a solid body and design, and is the result of a never-ending flow of development ideas that fulfill the UR series' commitment to audio quality—all in a compact package that has only those components that are absolutely necessary for basic music production.

The input routing is extremely simple, with a single mic preamp and a single HI-Z input jack. The mic preamp features the same "D-PRE" specifications as more advanced models in this series, for the same commitment to audio quality. In order to achieve the perfect balance between relaxed highs, dense mids, and a punchy low end, each component was carefully selected to design a basic model with a strong focus on sound quality.

The UR12 supports Windows, Mac, and iPad environments, to meet your needs for easy music production in a variety of situations with trademark UR-series audio quality. A 5V DC port has been provided to supply sufficient power to the UR12 when using it with an iPad. You can connect a USB power adapter or USB mobile battery to this port. A stable power supply allows this audio interface to perform at its maximum potential. This is one of the design decisions that allow you to achieve high-quality music production with the UR12 in a variety of environments.

There have been significant changes in music production environments recently. The UR12 has been designed with those changes in mind, and we hope that the UR12 helps more people enjoy music production, with greater ease of use and optimum audio quality, in a variety of situations and environments—so that you can fulfill your musical hopes and dreams.

The Steinberg Hardware
Development Team

Panel Controls and Terminals

Front Panel

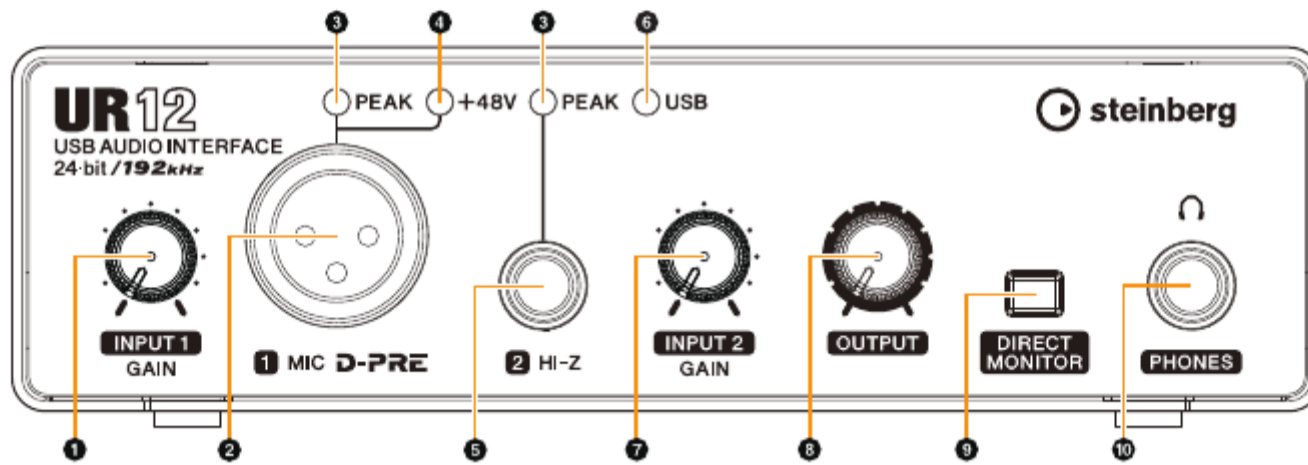

[INPUT 1 GAIN] knob

Adjusts the input signal level of the [MIC] jack.

[MIC] jack

For connecting a microphone.

[PEAK] indicator

Lights up when the input signal is 3dB below the clipping level.

HINT

Setting optimum recording levels

Adjust the gain knobs so that the [PEAK] indicator flashes briefly at the loudest input volume.

[+48V] indicator

Lights up when the [+48V] switch (phantom power) is turned on. The [+48V] switch is on the rear panel.

[HI-Z] jack

For connecting instruments with a high output impedance, such as electric guitars and basses. Use a phone-type (unbalanced) cable for connection.

[USB] indicator

Lights up when the power is turned on. If the computer or iPad does not recognize the device, this flashes continuously.

[INPUT 2 GAIN] knob

Adjusts the input signal level of the [HI-Z] jack.

[OUTPUT] knob

Adjusts the output signal level of the [PHONES] and [LINE OUTPUT] jacks. The output signal level of the [PHONES] and [LINE OUTPUT] jacks are adjusted simultaneously.

NOTE

[DIRECT MONITOR] switch

Turns the DIRECT MONITOR function on () or off (). When the DIRECT MONITOR function is turned on, the audio signal sent from the computer and the audio signal input from the [MIC]/[HI-Z] jacks are output directly to the [PHONES]/[LINE OUTPUT] jacks.

HINT

Using this switch

To monitor audio from the input jacks via the DAW software (for example, when you also want to hear the software effects), turn this switch off. If the software latency bothers you, or if you always want to monitor the input signal, turn this switch on.

[PHONES] jack

For connecting a set of headphones.

Rear Panel

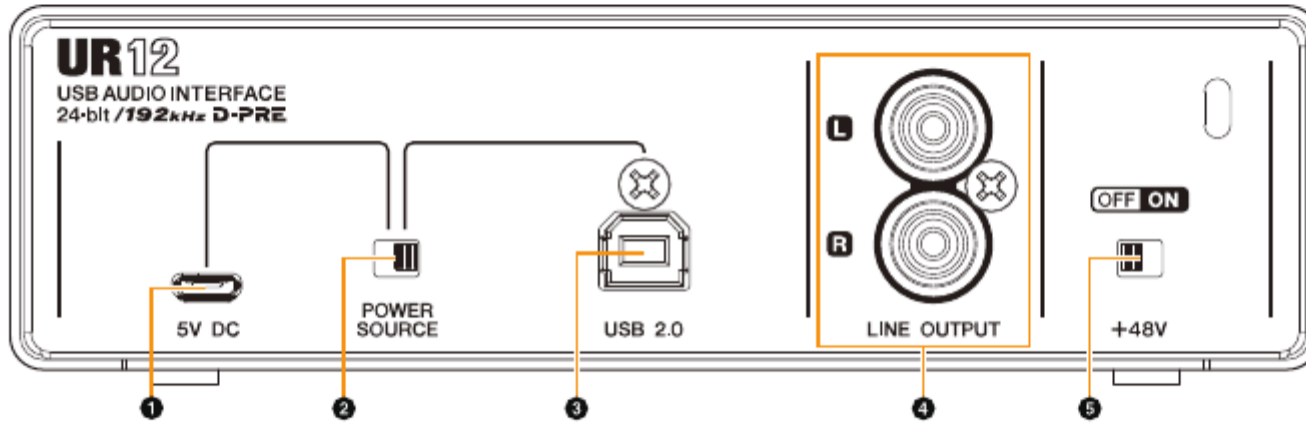
**[5V DC] port**

For connecting a USB power adapter or USB mobile battery. Use a power supply when connecting the UR12 to a device that does not supply sufficient bus power, such as an iPad. (The UR12 does not include a USB power adapter or USB mobile battery.)

NOTICE

- Read the safety precautions for the USB power adapter or USB mobile battery that you use.
- Use a USB power adapter or USB mobile battery that can supply power in compliance with USB standards with a 5-pin micro USB plug.

Output voltage: 4.8 V to 5.2 V

Output current: 0.5 A or greater

HINT**Using the [5V DC] port**

Even when the UR12 is connected to a computer, you can supply power via the [5V DC] port by external power supply if the [POWER SOURCE] switch is set to the [5V DC] side.

This can be used to avoid power supply problems. For example, ground loops due to differences in voltage potential can occur if the device connected to the UR12 is using the same power outlet as the computer, and audio quality degradation can occur if the power supply from the computer's USB port is not stable.

[POWER SOURCE] switch

For selecting the port for supplying power to the UR12. To supply bus power via the [USB2.0] port, set this switch to the [USB2.0] side. To supply power via the [5V DC] port, set this switch to the [5V DC] side. When using an iPad, set this switch to the [5V DC] side. Even if you set the power supply to [5V DC], the power to the UR12 will not come on unless it is connected to a computer or an iPad by the [USB 2.0] port.

NOTE**[USB2.0] port**

For connection to a computer or iPad.

USB Port Precautions

Be sure to observe the following points when connecting the device to the computer's USB interface. Failing to do so may result in the computer freezing or shutting down, as well as corruption or even loss of data. If the device or computer does freeze, restart the application or computer.

NOTICE

- Use an AB type USB cable. USB 3.0 cables are not supported.
- Be sure to wake the computer from sleep/suspended/standby mode before connecting it to the UR12 with a USB cable.
- Before connecting/disconnecting the USB cable, quit all open software applications on the computer.
- Before connecting or disconnecting the USB cable from the [USB2.0] port, be sure to set the [OUTPUT] knob to the minimum.
- Do not connect/disconnect the USB cable in rapid succession. Wait at least six seconds between connecting/disconnecting the USB cable.

[LINE OUTPUT] jacks

For connecting monitor speakers. Use RCA connectors (unbalanced) to connect to these jacks.

[+48V] switch

Turns the phantom power (+48V) on/off. When you turn this switch on, phantom power will be supplied to the [MIC] jack.

Phantom Power Precautions

NOTICE

Always turn the phantom power switch to [OFF] when it is not required.

When using phantom power, observe the following to prevent noise and possible damage to UR12 or connected equipment.

- Set the [OUTPUT] knob to minimum before turning the phantom power switch to [ON] or [OFF].
- Do not connect or disconnect any devices while the phantom power switch is turned to [ON].
- When connecting devices not requiring phantom power to the [MIC] jack, make sure to turn the phantom power switch to [OFF].

Software

Yamaha Steinberg USB Driver is a software program that allows communication between the UR12 and a computer. In Control Panel, you can configure the basic settings for the audio driver (Windows) or confirm the audio driver information (Mac).

NOTE

Configuring the Yamaha Steinberg USB Driver (Windows)

How to Open the Window

- Select [Control Panel] → [Hardware and Sound] or [Sounds, Speech, and Audio Devices] → [Yamaha Steinberg USB Driver].
- From the Cubase series menu, select [Devices] → [Device Setup...] → [Yamaha Steinberg USB ASIO] → [Control Panel].

How to Select Windows

Click the upper tabs to select the desired window.

Steinberg UR12 Window

This window is for selecting the sample rate and Loopback settings of the device.

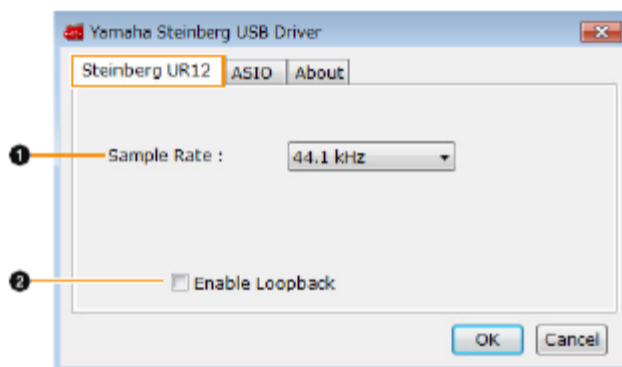

Sample Rate

Lets you select the sample rate of the device.

Options: 44.1 kHz, 48 kHz, 88.2 kHz, 96 kHz, 176.4 kHz, 192 kHz

NOTE

Enable Loopback

Use the check box to turn Loopback on/off.

HINT

What is Loopback?

Loopback is a convenient function for broadcasting over the Internet. It mixes the input audio signals (such as microphone and guitar) with the audio signals playing back in the software in the computer into two channels in the UR12, and sends them back to the computer.

Loopback Function Precautions

If the Loopback function is on while you are monitoring input signals from the UR12 via DAW software, it will cause loud noise. This is because an infinite loop of the audio signal is generated between the UR12 and the DAW software. When using the loopback function, turn off the monitor functions on your DAW software.

ASIO Window

For selecting the ASIO driver settings.

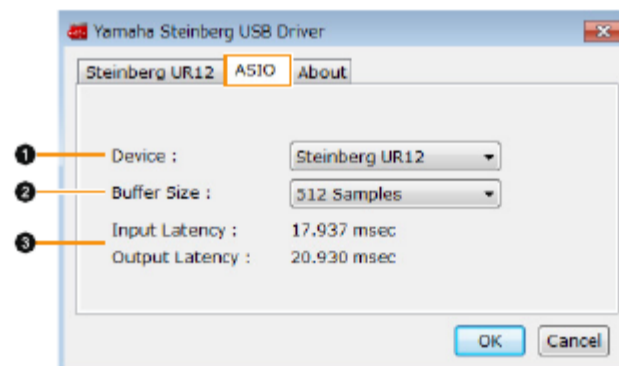

Device

Lets you select the device that will be using the ASIO driver. (This function is available when connecting two or more devices that are compatible with the Yamaha Steinberg USB Driver to the computer.)

Buffer Size

Lets you select the buffer size for the ASIO driver. The range varies depending on the specified sample rate.

Sample Rate	Range
44.1 kHz/48 kHz	64 Samples - 2048 Samples
88.2 kHz/96 kHz	128 Samples - 4096 Samples
176.4 kHz/192 kHz	256 Samples - 8192 Samples

Input Latency/Output Latency

Indicates the latency (delay time) for the audio input and output in millisecond units.

Audio latency varies depending on the value of the ASIO buffer size. The lower the value of the ASIO buffer size, the lower the value of audio latency.

About Window

Indicates the version and copyright of the audio driver.

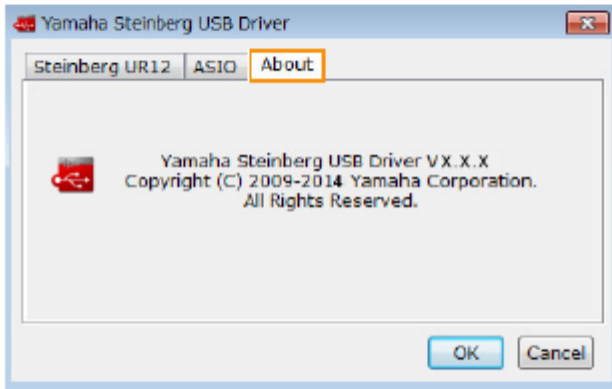

About Window

Indicates the version and copyright of the audio driver.



Configuring the Yamaha Steinberg USB Driver (Mac)

How to Open the Window

- Select [System Preferences] → [Yamaha Steinberg USB].
- From the Cubase series menu, select [Devices] → [Device Setup...] → [Steinberg UR12] → [Control Panel] → [Open Config App].

Steinberg UR12 Window

For selecting the Loopback settings.

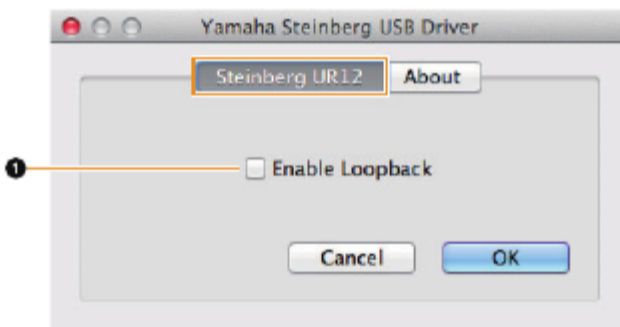

Enable Loopback

Use the check box to turn Loopback on/off.

How to Select the Sample rate (Mac)

You can select the sample rate in [Audio MIDI Setup] window.

How to Open the Window

Select [Applications] → [Utilities] → [Audio MIDI Setup].

Select the sample rate from [Format] menu.

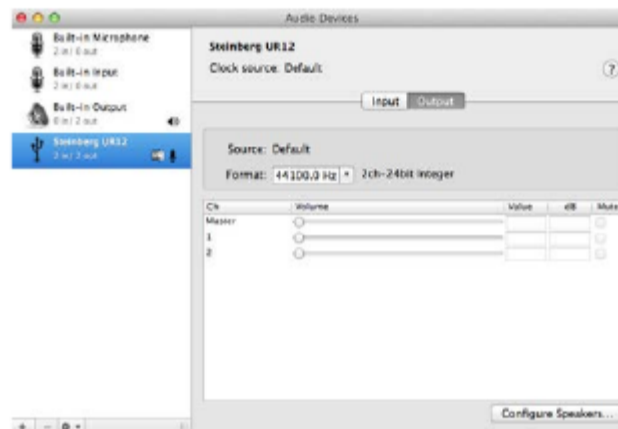

How to Select the Buffer Size (Mac)

You can select the buffer size in the settings window for each application (DAW software, etc.).

How to Open the Window

From the Cubase series menu, select [Devices] → [Device Setup...].

NOTE

Click [Control Panel] in [Steinberg UR12] in the menu on the left side of the window.

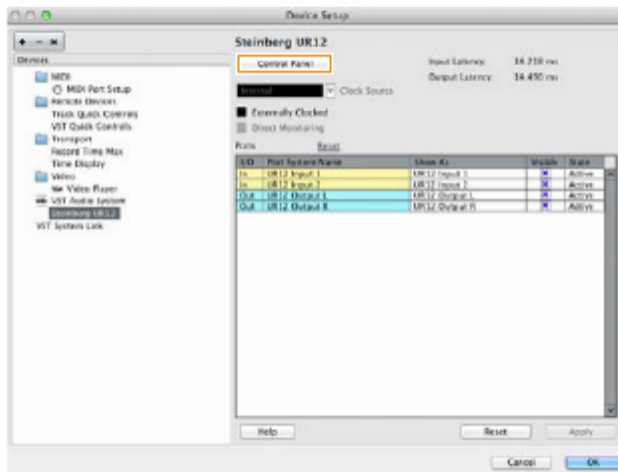

The window for selecting the buffer size appears.

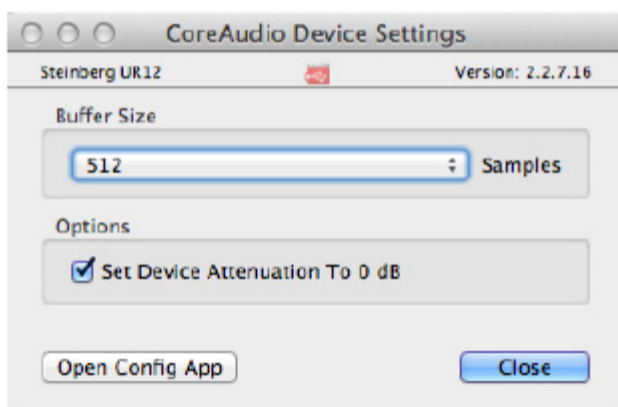

Using the UR12

Connection Examples



Make sure that you set all volume levels to minimum before connecting or disconnecting the external device. Otherwise, high-volume output may damage your hearing or the equipment.

Connecting to a Computer

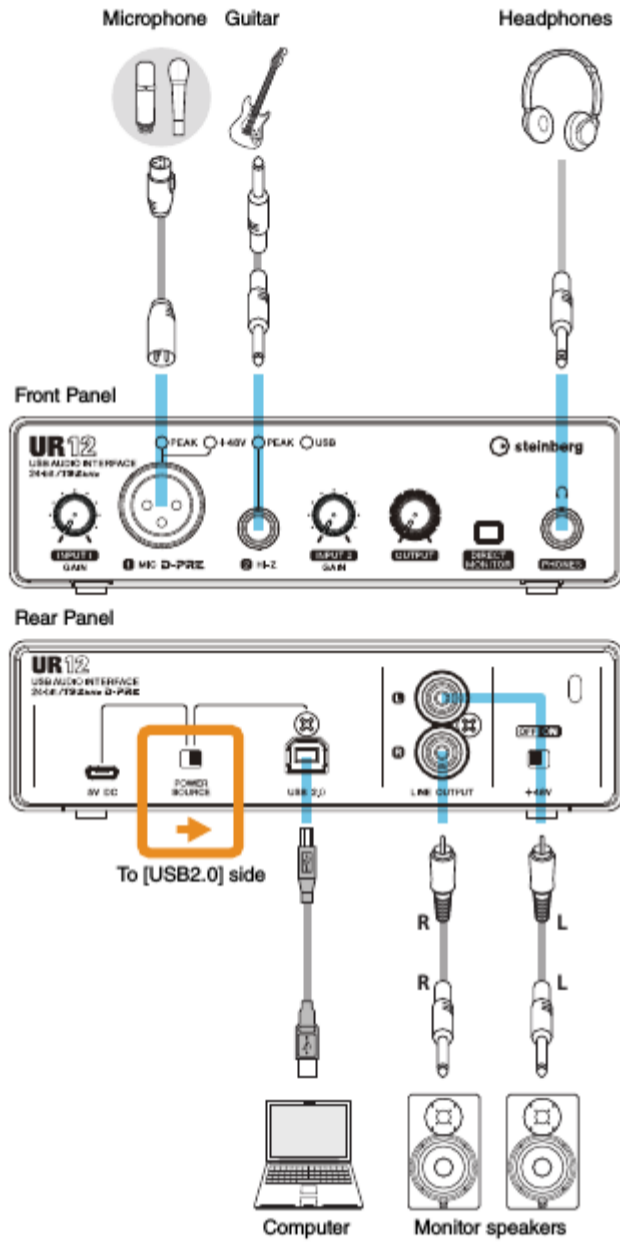

Connecting to an iPad

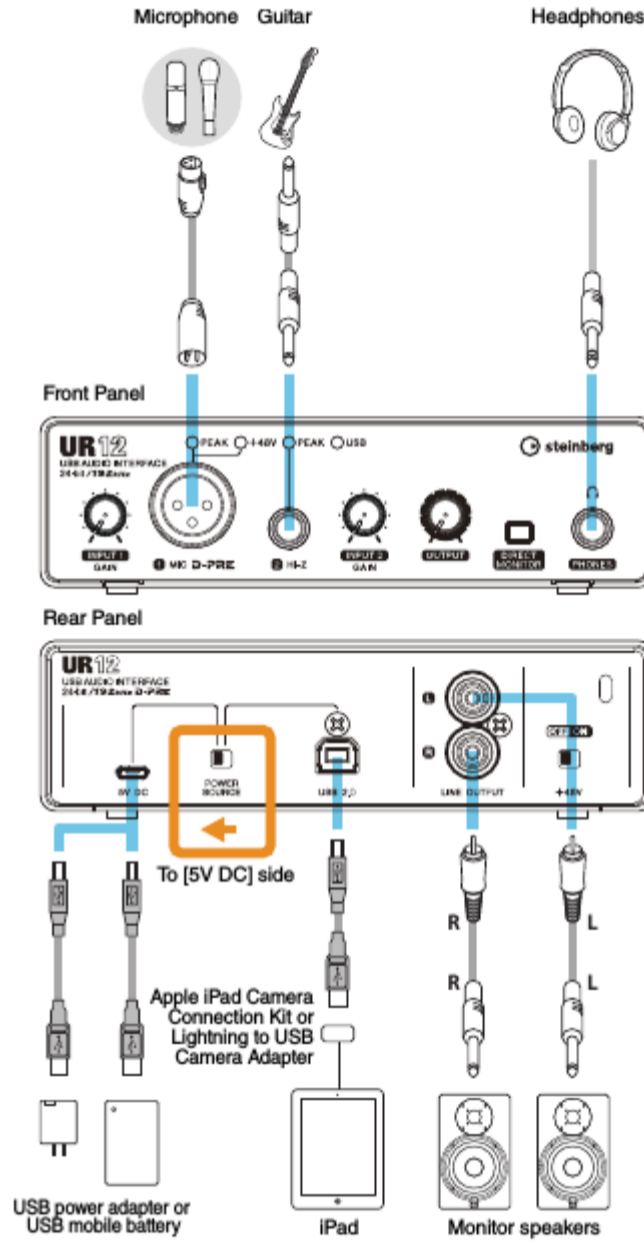

NOTE

Apple iPad Camera Connection Kit or Lightning to USB Camera Adapter are required when connecting the UR12 with an iPad. For the latest information on compatible iOS devices, refer to the Steinberg Website below. <http://www.steinberg.net/>

Configuring Audio Driver Settings on the DAW Software

This section provides examples of connecting the UR12 to a computer.

Cubase Series Programs

Close your DAW software if it is running.

Move the [POWER SOURCE] switch on the rear panel to the [USB2.0] side.

Connect the device directly to the computer by using the included USB cable.

NOTE

(Windows only) Connect the USB cable to the same USB port that you used when installing the Yamaha Steinberg USB Driver. If you connect the USB cable to a different USB port, the Yamaha Steinberg USB Driver will be installed again.

Launch the Cubase series DAW.

When the [ASIO Driver Setup] window appears while the Cubase series program is launching, confirm that the device is selected, then click [OK].

The audio driver settings are now complete.

Programs other than Cubase Series

Move the [POWER SOURCE] switch on the rear panel to the [USB2.0] side.

Connect the device directly to the computer by using the included USB cable.

NOTE

Connect only 1 device that supports the Yamaha Steinberg USB Driver.

(Windows only) Connect the USB cable to the same USB port that you used when installing the Yamaha Steinberg USB Driver. If you connect the USB cable to a different USB port, the Yamaha Steinberg USB Driver will be installed again.

Launch the DAW software.

Open the audio interface settings window.

(Windows only) Select the ASIO Driver for the audio driver settings.

Set the ASIO Driver for Windows and audio interface for Mac as follows.

Windows

Set the ASIO Driver settings to [Yamaha Steinberg USB ASIO].

Mac

Set the UR12 to the appropriate audio interface settings.

The audio driver settings are now complete.

Recording/Playback

Connect a microphone or guitar as shown in the connection examples (page 9). Turn the [+48V] switch on when using a phantom powered condenser microphone.

Cubase Series Programs

The [steinberg hub] window appears.

Select a project template in [Recording], then click [Create].

The following example uses the [Clean E-Guitar + Vocal] template.

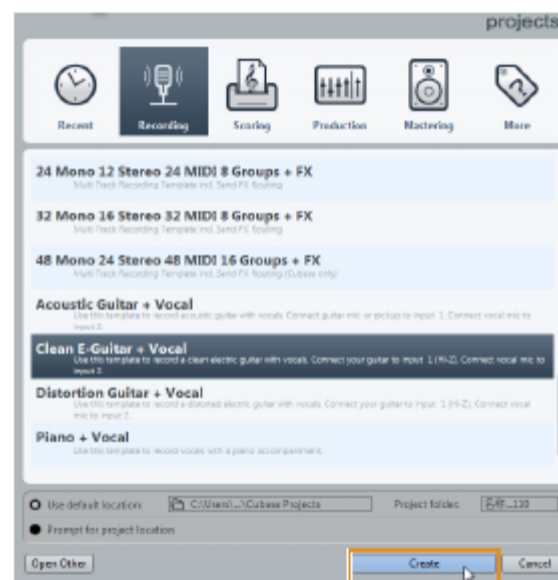

NOTE

If the [Missing Ports] window appears, select a UR12 port for each [Mapped ports].

Check [Map Always], and then click [OK]. By checking [Map Always], the [Missing Ports] window will not appear again.

Select [Devices] → [VST Connections] and open [VST Connections] window.

Select UR12 ports for [Device Port] on both the Inputs and Outputs tabs.

Inputs Tab

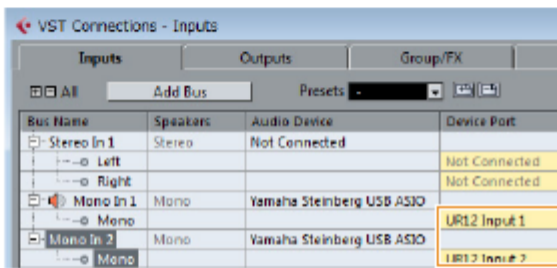

Outputs Tab

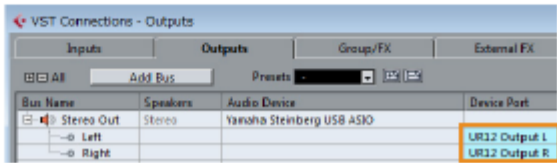

Turn on () the [DIRECT MONITOR] switch on the front panel.

Adjust the input signal level of the microphone or guitar with the [INPUT GAIN] knob on the device.

If you have a microphone connected to the [MIC] jack, adjust the [INPUT 1 GAIN] knob. If you have a guitar connected to the [HI-Z] jack, adjust the [INPUT 2 GAIN] knob.

Setting optimum recording levels

Adjust the gain knobs so that the [PEAK] indicator flashes briefly at the loudest input volume.

While singing into the microphone or playing the guitar, adjust the output signal level of the headphones with the [OUTPUT] knob on the device.

Select desired track for recording.

Select the input routing.

When a microphone is connected to the [MIC] jack: Click on the track, and then click the track name on the left side of the project window.

NOTE

If the track name is not shown in the inspector, close the currently displayed section (initial setting is [Fader]).



In the window that appears below, select [Mono-In 1].



When a guitar is connected to the [HI-Z] jack:

Click on the track, and then click the track name on the left side of the project window.

NOTE

If the track name is not shown in the inspector, close the currently displayed section (initial setting is [Fader]).

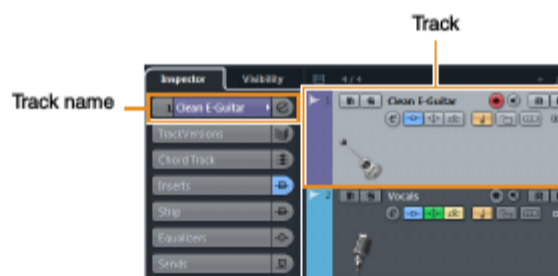

In the window that appears below, select [Mono-In 2].



Click [] to start the recording.



After finishing the recording, click [] to stop recording.



Click the Ruler to move the project cursor to the desired point for starting playback.

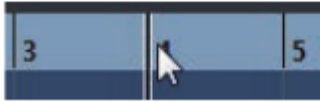

Click [] to check the recorded sound.

When listening to the sound over monitor speakers, adjust the output signal level by the [OUTPUT] knob on the device.



The recording and playback operations are now complete.

For more detailed instructions on using Cubase series programs, refer to the PDF manual, available from [Help] in the Cubase series menu.

Programs other than Cubase Series

Turn on () the [DIRECT MONITOR] switch on the front panel.

Adjust the input signal level of the microphone or guitar with the [INPUT GAIN] knob on the device.

If you have a microphone connected to the [MIC] jack, adjust the [INPUT 1 GAIN] knob. If you have a guitar connected to the [HI-Z] jack, adjust the [INPUT 2 GAIN] knob.

Setting optimum recording levels

Adjust the gain knobs so that the [PEAK] indicator flashes briefly at the loudest input volume.

While singing into the microphone or playing the guitar, adjust the output signal level of the headphones by the [OUTPUT] knob on the device.

Start recording on your DAW software.

After finishing recording, stop it.

Playback the newly recorded sound to check it.

The recording and playback operations are now complete.

For more detailed instructions on using the DAW software, refer to your particular DAW's software manual.

Troubleshooting

Power does not turn on	<p>Has the Yamaha Steinberg USB Driver been installed properly? Refer to the Getting Started instructions to complete the Yamaha Steinberg USB Driver installation.</p>
	<p>Confirm whether or not a proper USB cable is being used. If the USB cable is broken or damaged, replace the USB cable with a new one. Make sure to use a USB cable no longer than 3 meters.</p>
	<p>Is the [POWER SOURCE] switch set properly? First, disconnect the USB cable (if used) from the computer. Set the power source switch accordingly: to [USB2.0] when using bus-powered operation, or to [5V DC] when connecting to a USB AC adapter or USB portable battery.</p>
No sound	<p>Has the Yamaha Steinberg USB Driver been installed properly? Refer to the Getting Started instructions to complete the Yamaha Steinberg USB Driver installation.</p>
	<p>Are the volume controls of the device set to appropriate levels? Confirm the levels of the [OUTPUT] knob.</p>
	<p>Are the microphones and monitor speakers properly connected to the device properly? Refer to the section "Connection Examples" (page 9) to confirm the connection.</p>
	<p>Are the audio driver settings on DAW software set properly? Refer to the section "Configuring the Audio Driver Settings on DAW Software" (page 10) to set it.</p>
	<p>Is the [ASIO Driver] setting on the Cubase series program set properly? From the Cubase series menu, open the [Devices] → [Device Setup...] → [VST Audio System], then confirm that the [Yamaha Steinberg USB ASIO] (Windows) or [Steinberg UR12] (Mac) is selected on the [ASIO Driver].</p>
	<p>Was the power of the device turned on before starting the DAW software? Before starting the DAW software, connect the device to a computer and turn on the power of the device.</p>
	<p>Are any USB devices you are not using connected to the computer? Remove them, and then check the sound again.</p>
	<p>Are any other applications running at the same time? Quit all applications you are not using and check the sound again.</p>

Unusual sound (noise, interruption, or distortion)	<p>Is the buffer size set too low?</p> <p>Increase the buffer size compared to the current settings; refer to the section "Configuring the Yamaha Steinberg USB Driver (Windows)" (page 6) or "Configuring the Yamaha Steinberg USB Driver (Mac)" (page 7) for instructions.</p>
	<p>Does your computer satisfy the system requirements?</p> <p>Confirm the system requirements. For the latest information, see the Steinberg Website below. http://www.steinberg.net/</p>
	<p>Are you recording or playing long continuous sections of audio?</p> <p>The audio data processing capabilities of your computer will depend on a number of factors including CPU speed and access to external devices. Reduce the audio tracks and check the sound again.</p>
	<p>Is a network adaptor for wired/wireless LAN running?</p> <p>Disable the suspected network adaptor. Some network adaptors can cause noise.</p>
	<p>Is the Loopback function set properly?</p> <p>Set Enable Loopback to Off when not using the Loopback function. Refer to the section "Configuring the Yamaha Steinberg USB Driver (Windows)" (page 6) or "Configuring the Yamaha Steinberg USB Driver (Mac)" (page 7) for instructions.</p>
	<p>Is the Monitor speaker switch turned on?</p> <p>Confirm that the monitor speaker switch is turned on.</p>
Sound overlapping	<p>Is the DIRECT MONITOR switch set properly?</p> <p>Both direct sound and sound effects can be heard when software effects (plugins) are used with the [DIRECT MONITOR] switch set to ON. When the switch is set to OFF, only the sound effects can be heard.</p>

For the latest support information, refer to the Steinberg Website below.
<http://www.steinberg.net/>

Appendix

Block Diagrams

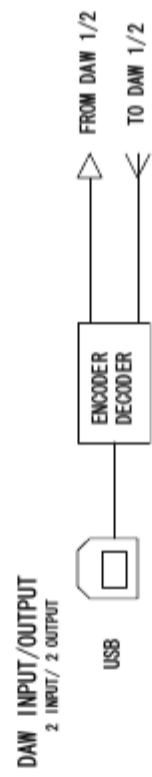
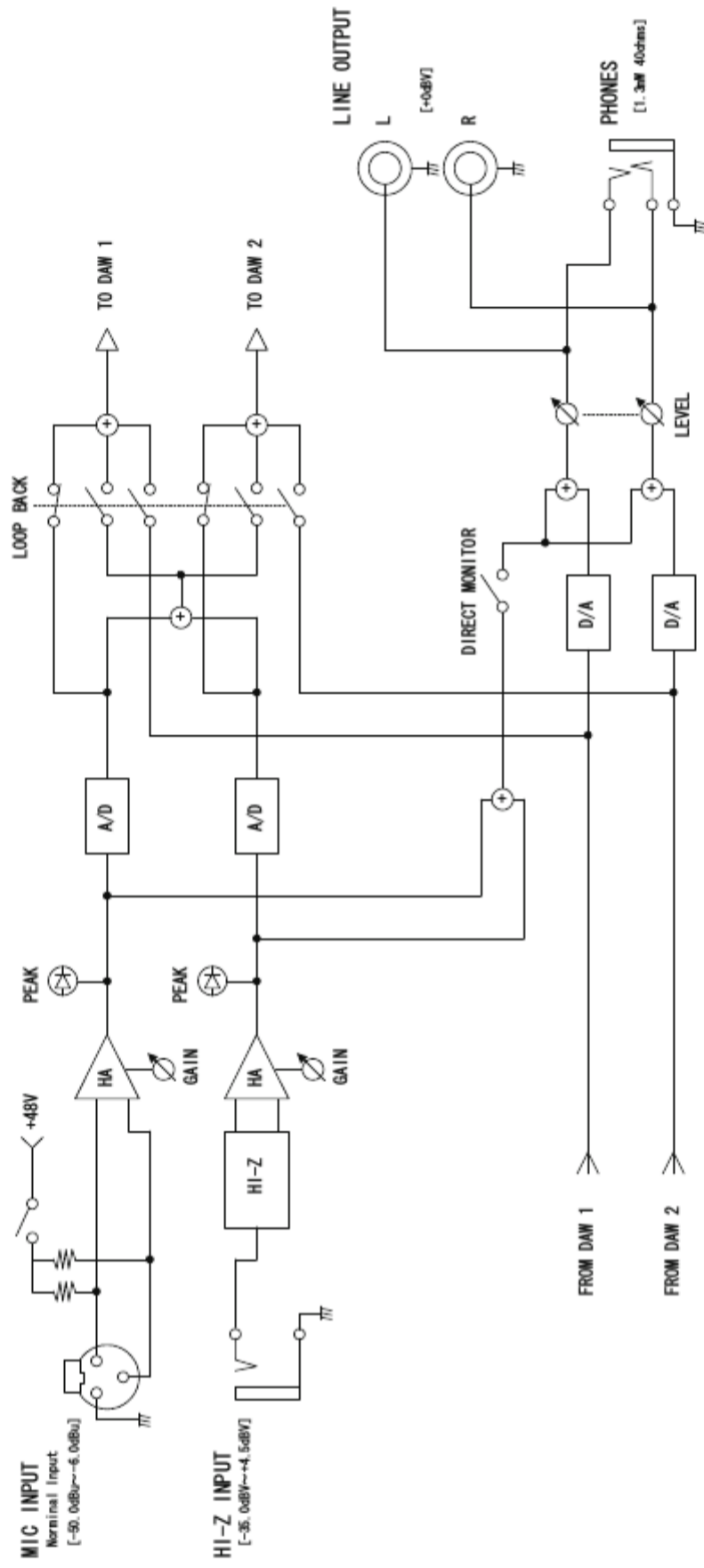

Steinberg Web Site
<http://www.steinberg.net/>

C.S.G., PA Development Division
© 2014 Yamaha Corporation

Published 10/2014 MWA0

